

VL-2020

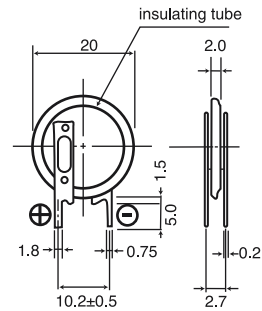

SPECIFICATIONS

Name	VL-2020
Nominal voltage (V)	3
Nominal capacity (mAh)	20.0
Continuous drain (mA)	0.07
Operating temperature (°C)	-20 to +60
Weight (g)	2.2

DISCHARGE TEMPERATURE CHARACTERISTICS

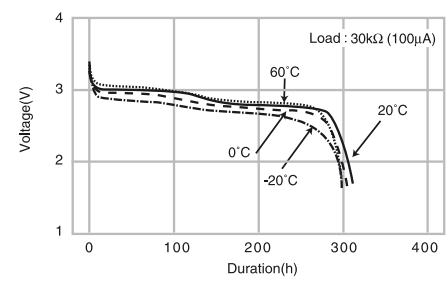

CONSUMPTION CURRENT VS. DURATION TIME

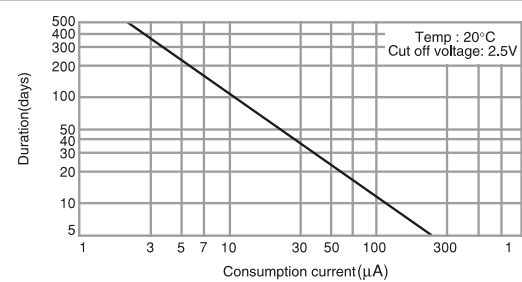

VL-2320

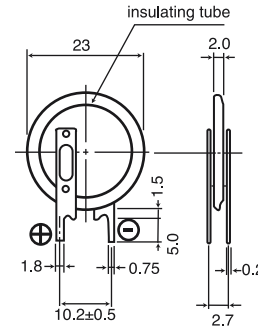

SPECIFICATIONS

Name	VL-2320
Nominal voltage (V)	3
Nominal capacity (mAh)	30.0
Continuous drain (mA)	0.1
Operating temperature (°C)	-20 to +60
Weight (g)	2.7

DISCHARGE TEMPERATURE CHARACTERISTICS

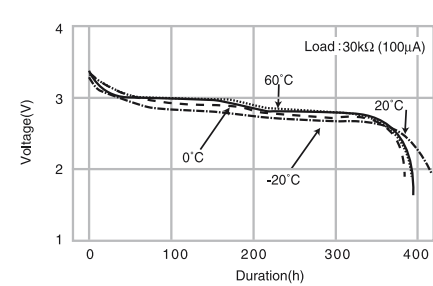

CONSUMPTION CURRENT VS. DURATION TIME

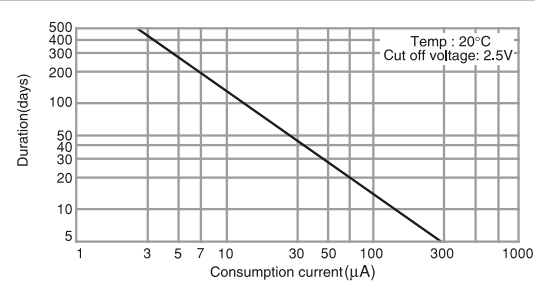

VL-2330

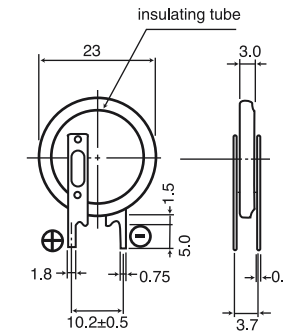

SPECIFICATIONS

Name	VL-2330
Nominal voltage (V)	3
Nominal capacity (mAh)	50.0
Continuous drain (mA)	0.1
Operating temperature (°C)	-20 to +60
Weight (g)	3.5

DISCHARGE TEMPERATURE CHARACTERISTICS

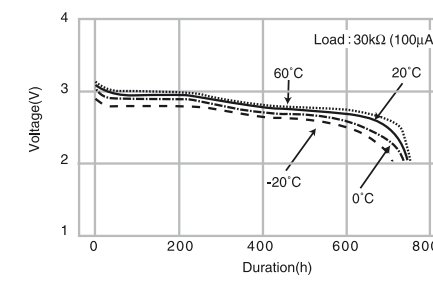

CONSUMPTION CURRENT VS. DURATION TIME

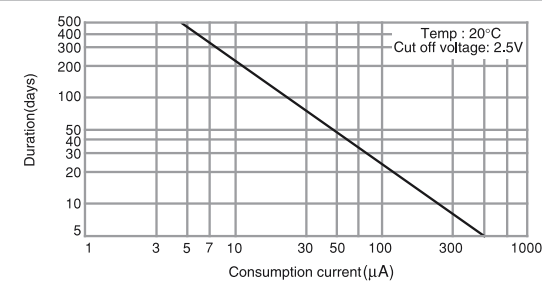

VL-3032

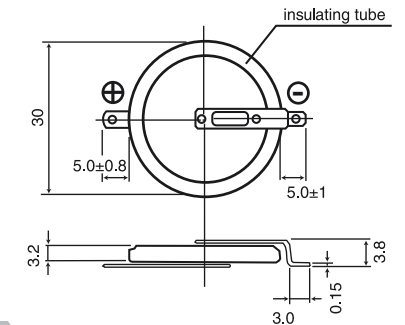

SPECIFICATIONS

Name	VL-3032
Nominal voltage (V)	3
Nominal capacity (mAh)	100.0
Continuous drain (mA)	0.2
Operating temperature (°C)	-20 to +60
Weight (g)	6.2

DISCHARGE TEMPERATURE CHARACTERISTICS

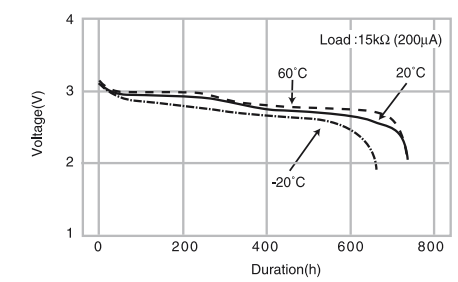

CONSUMPTION CURRENT VS. DURATION TIME

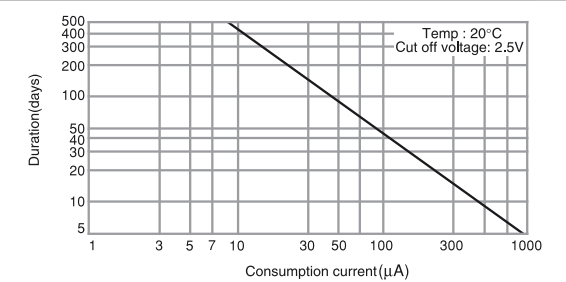

CYCLE LIFE (VL SERIES)

